

دکل ۷ متری با بازوی ۶ متری

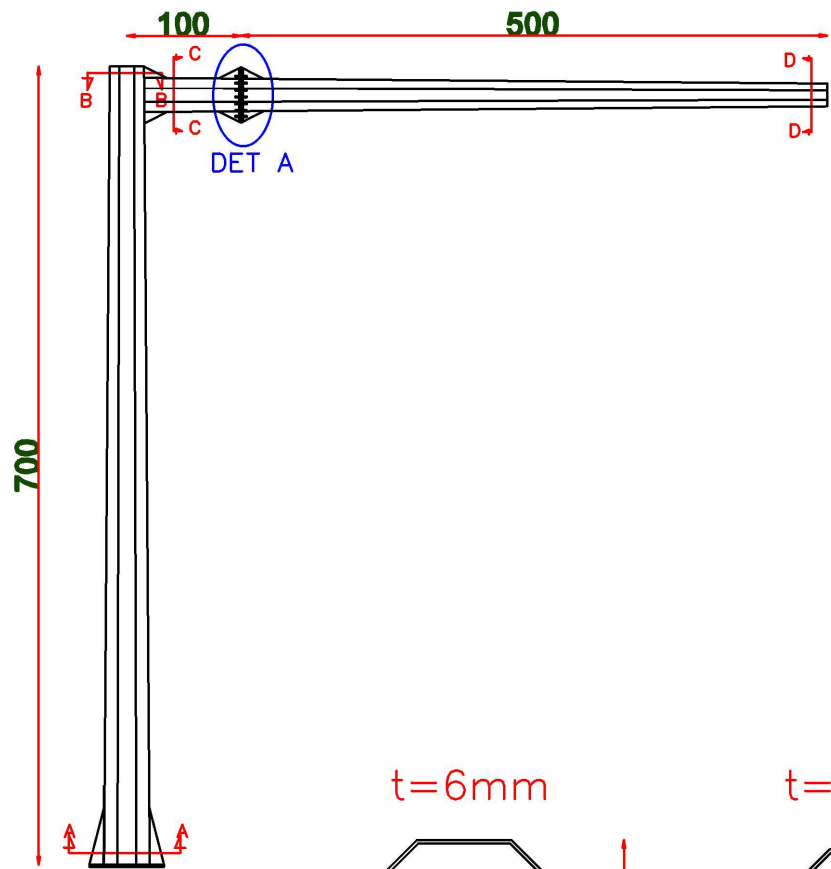

8 M20 70mm
PL 150x70x15
t=20mm

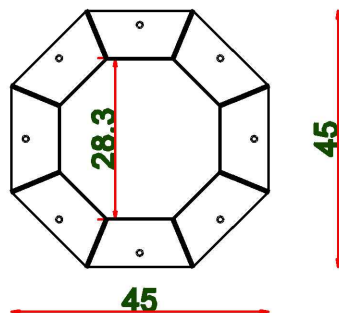

DET A
flang x2

8 M26 Ø28
PL 500x125x10
t=20mm

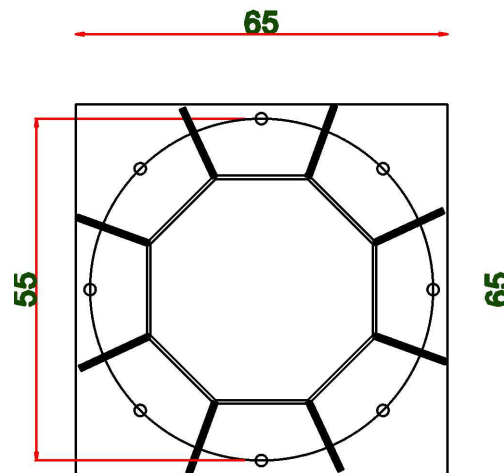

BASE PLATE

t=6mm

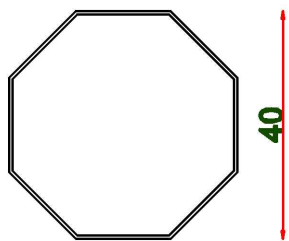

SEC A-A

t=6mm

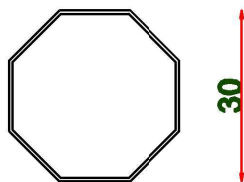

SEC B-B

t=4mm

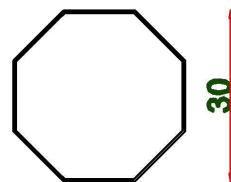

SEC C-C

t=4mm

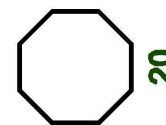

SEC D-D